



DESSINS TECHNIQUES
TECHNICAL DRAWINGS / TECHNISCHE ZEICHNUNGEN
DISEGNI TECNICI / DIBUJOS TECNICOS



Peugeot
306



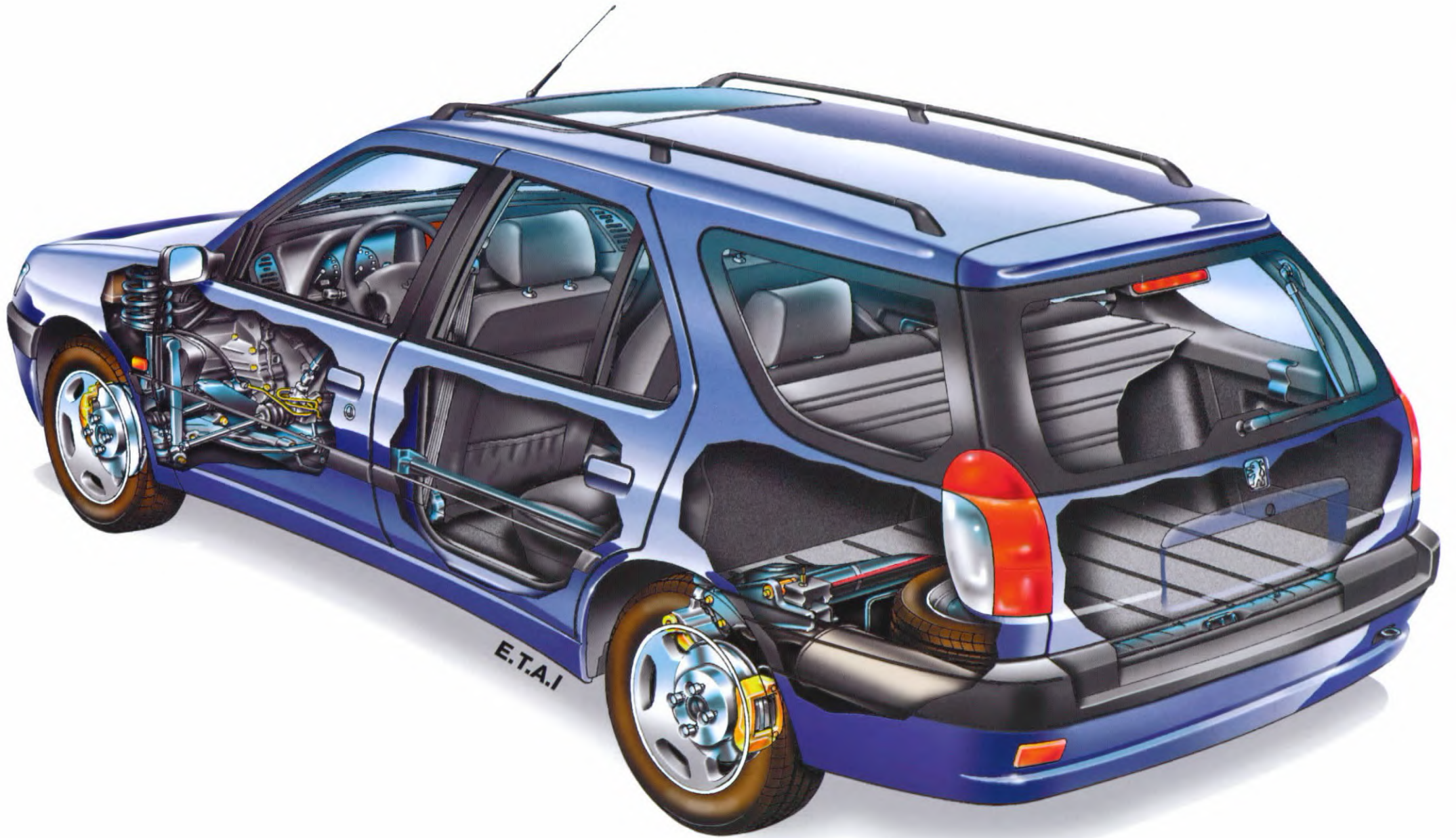

E.T.A.I

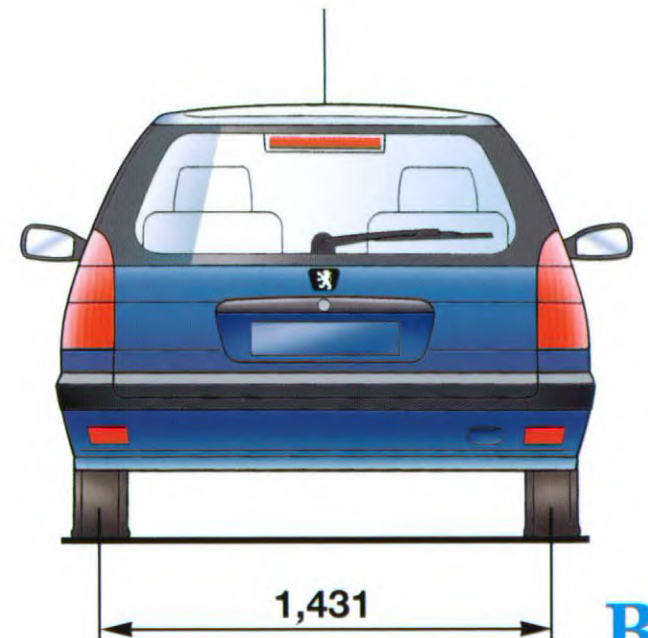
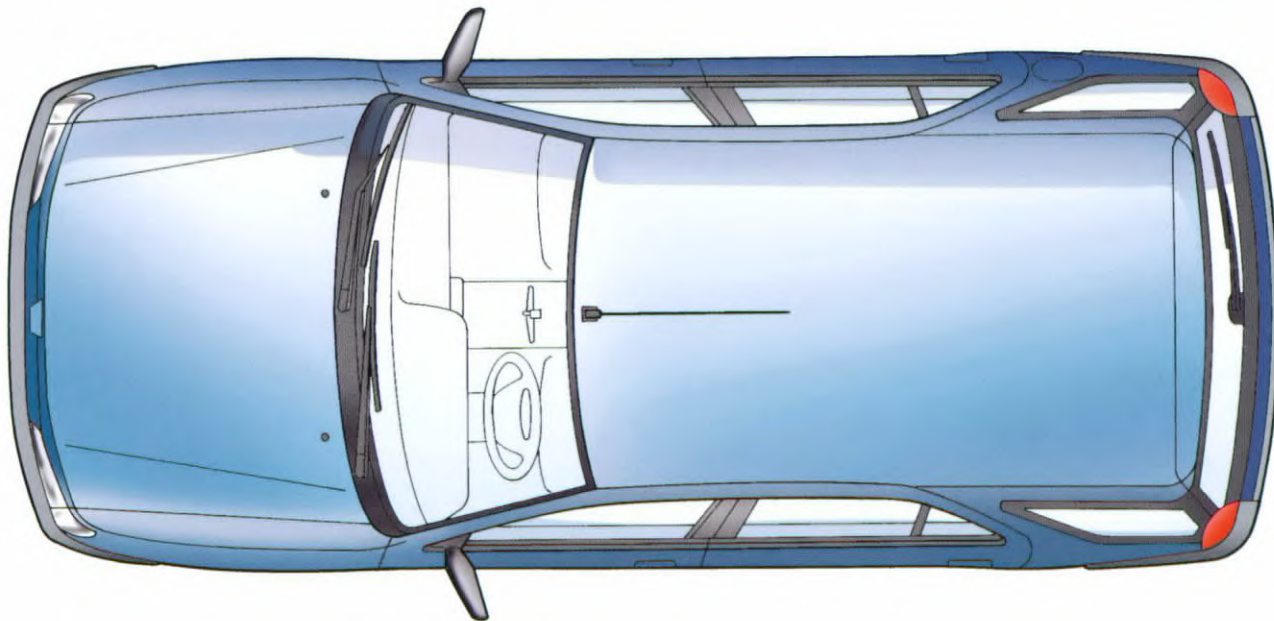
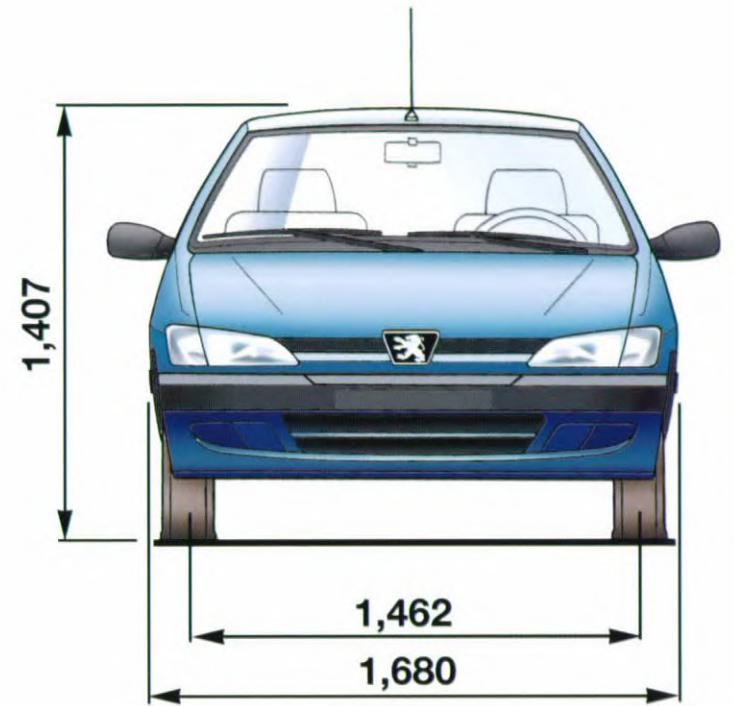
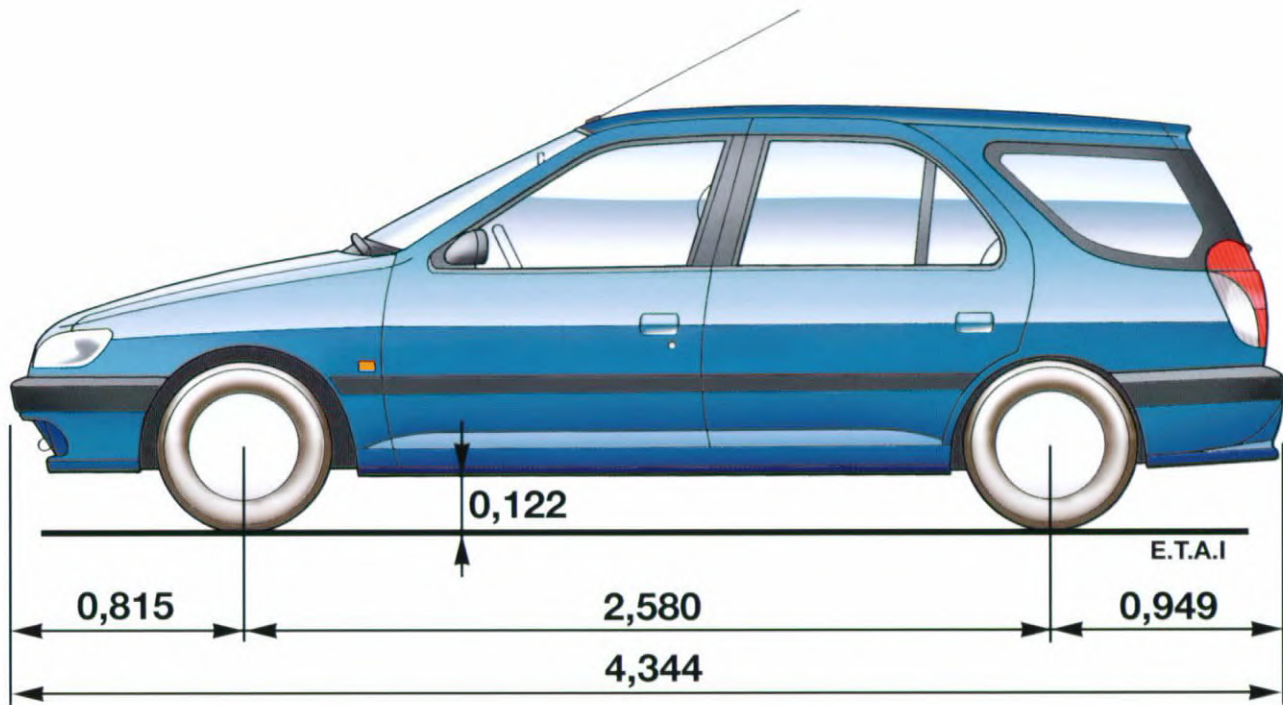

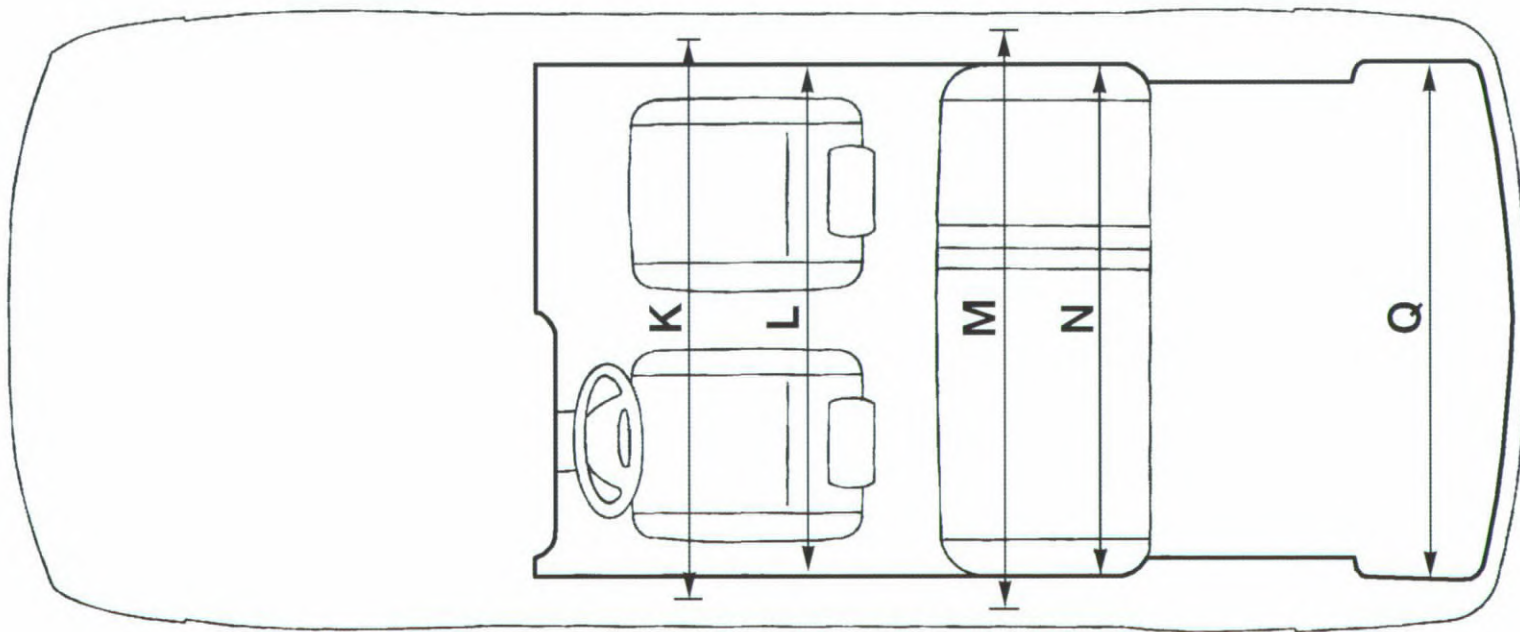
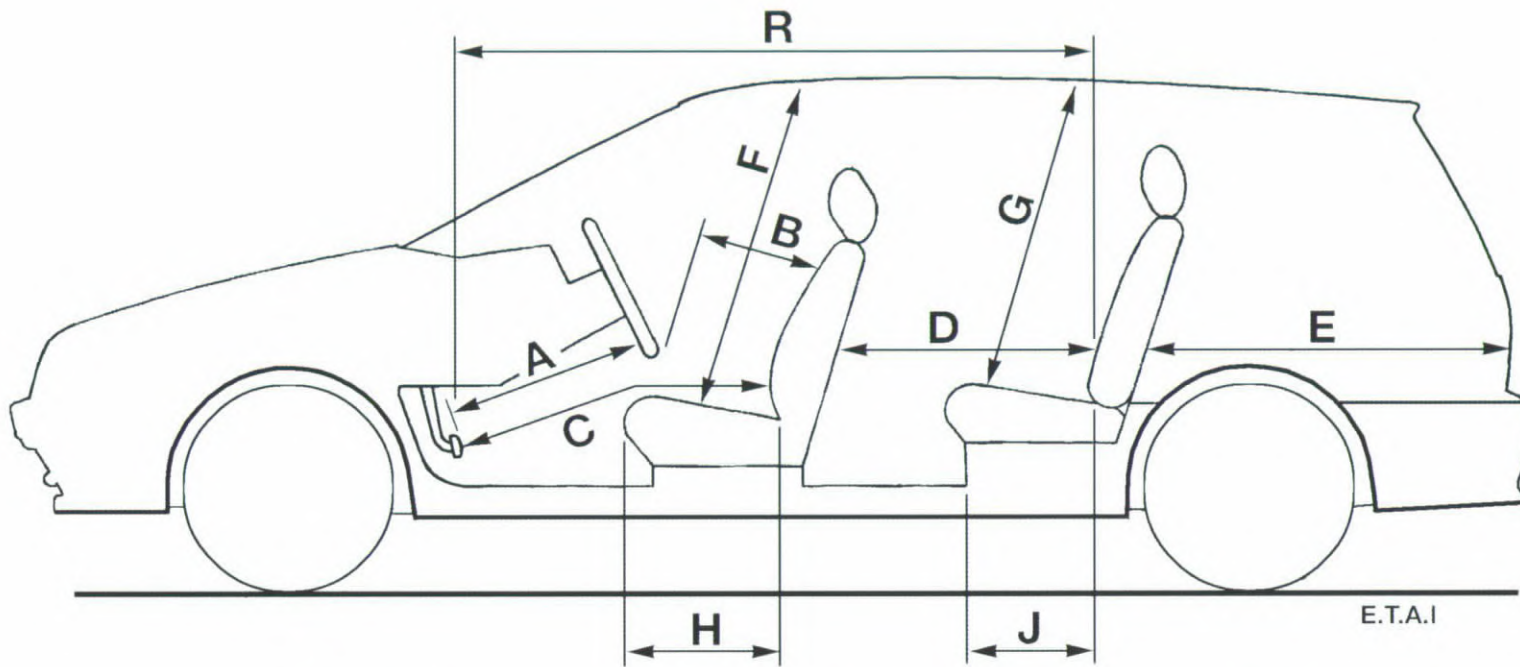

A	0,585
B	0,501
C	1,048
D	0,672
E	1,105
F	0,877
G	0,836
H	0,460
J	0,440
K	1,386
L	1,369
M	1,405
N	1,344
Q	1,148
R	1,658

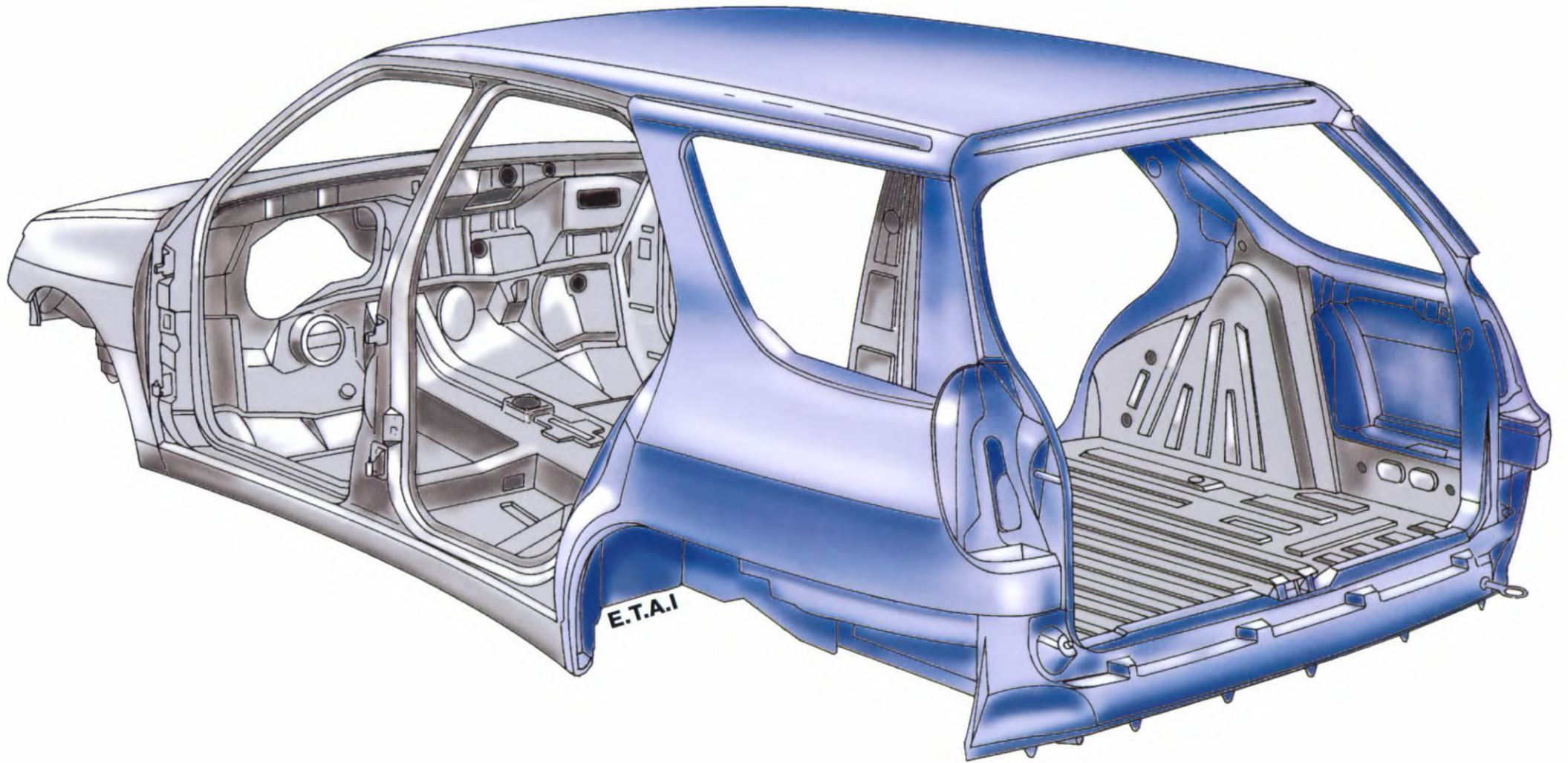

E.T.A.I

-  a
-  b

D

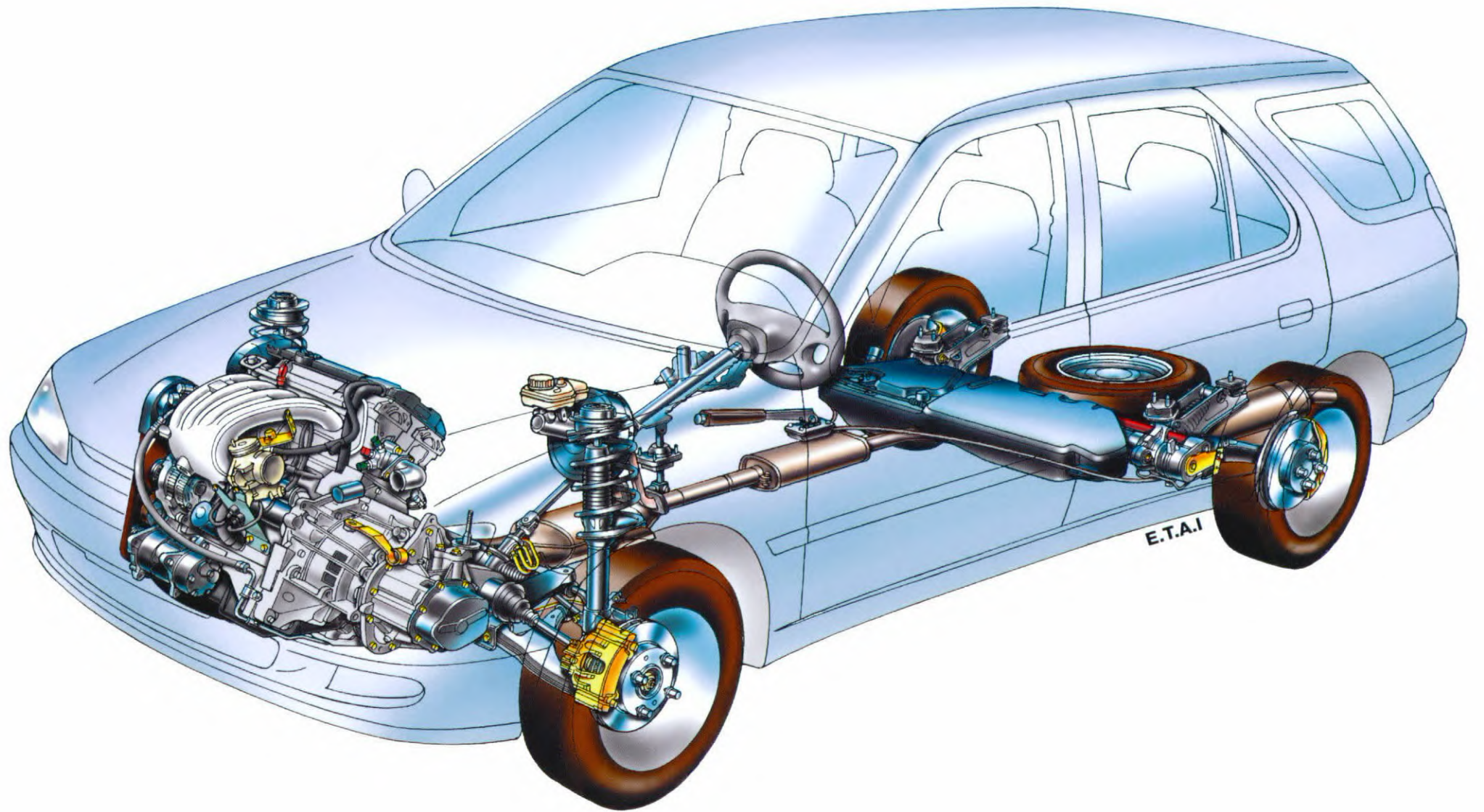

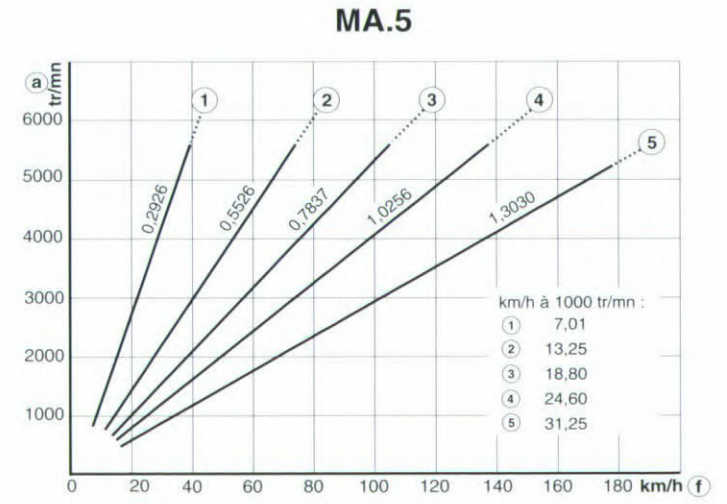
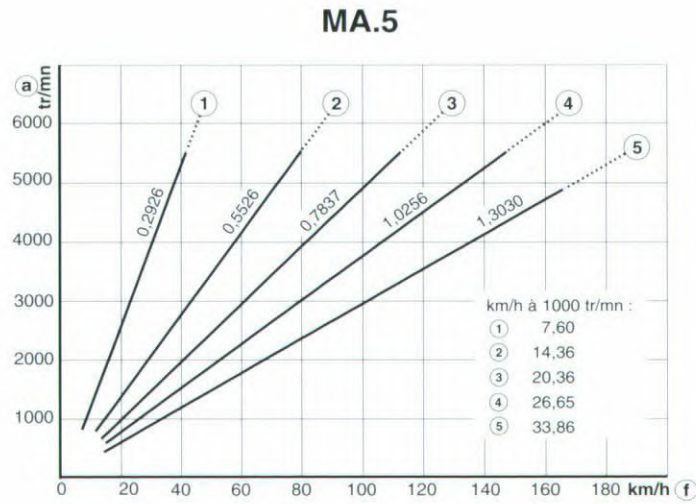
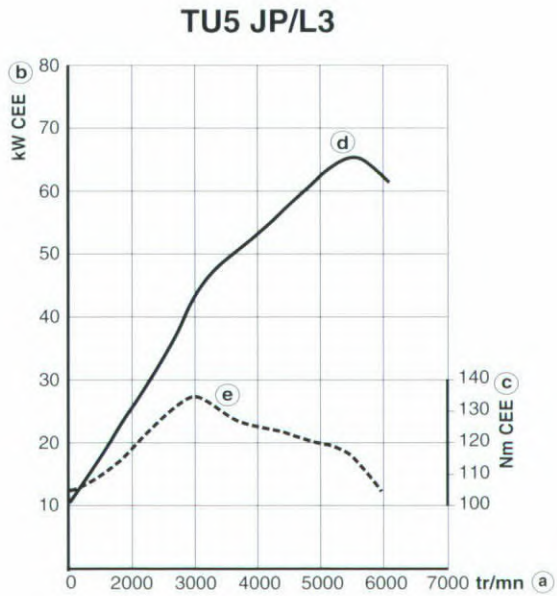
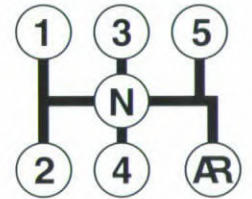
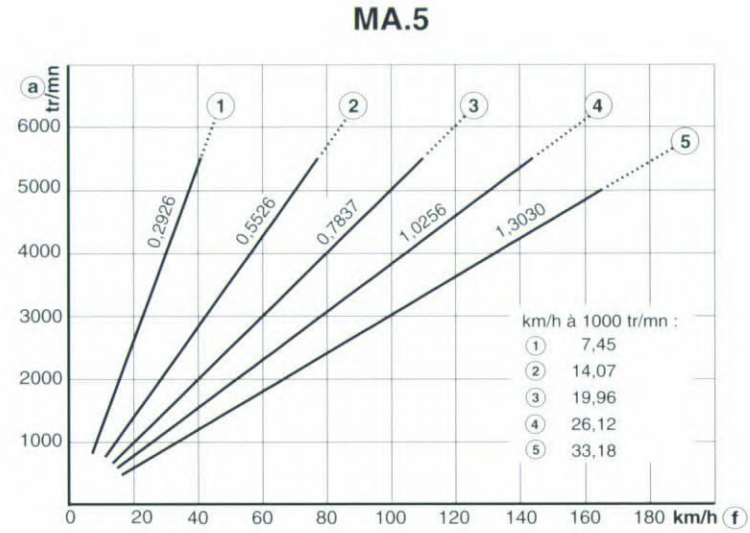
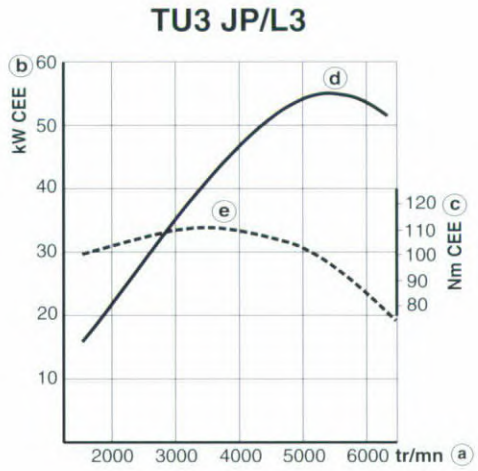

XUJ7 JP/L3

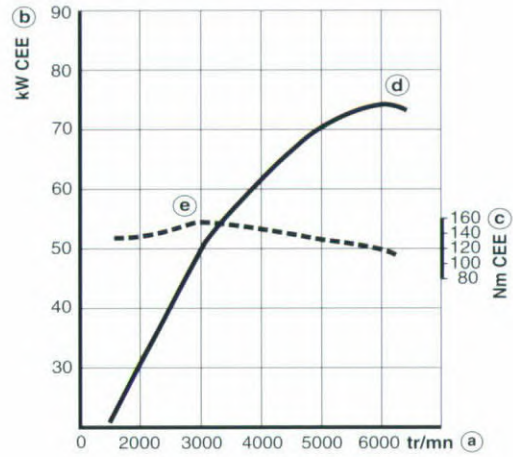

4HP 14

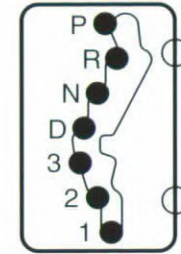
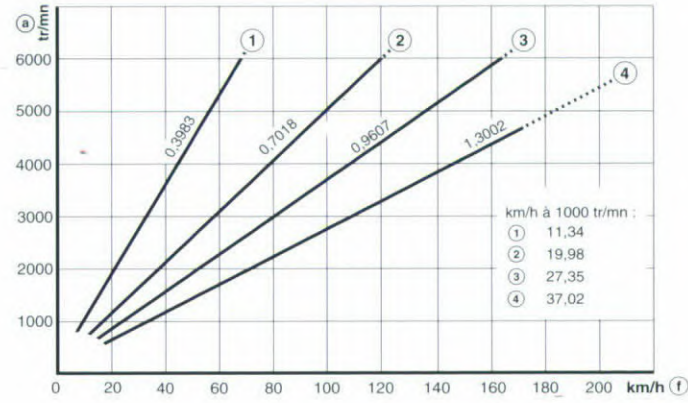

BE 3.5

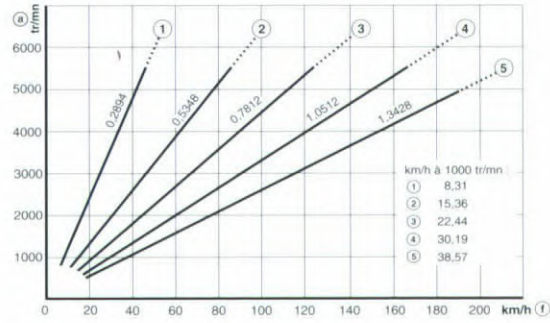

XUJ7 JP4/L3

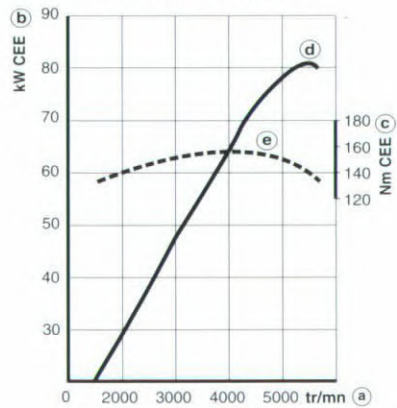

BE 3.5

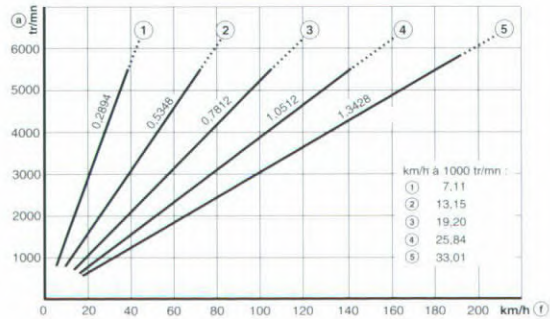

BE 3.5

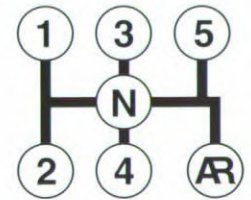
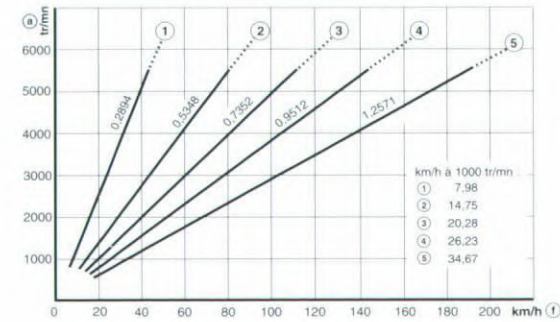



XU10 J4R/L3

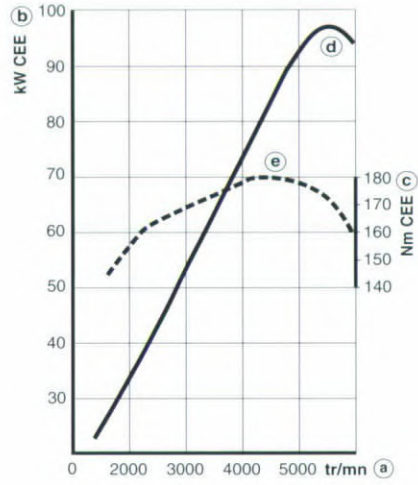

BE 3.5

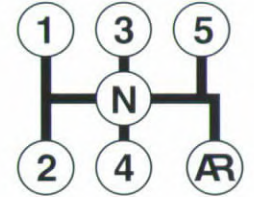
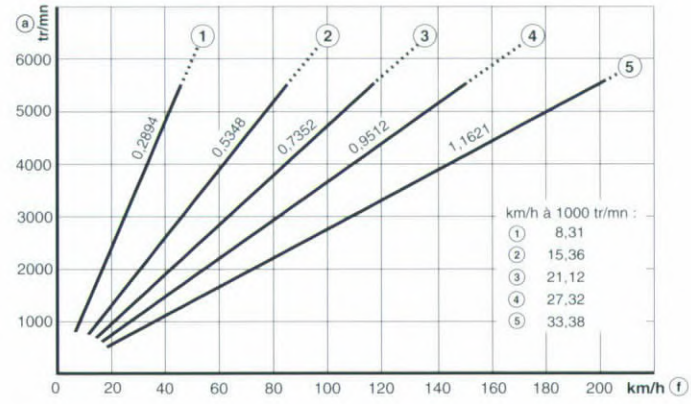

XU10 J4RS/L3

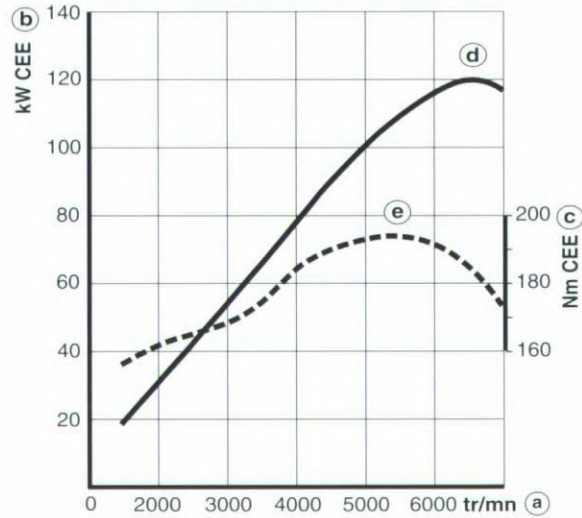

BE 3.6

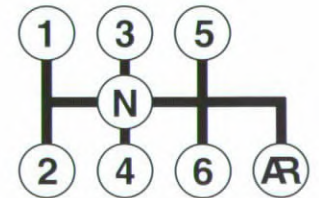
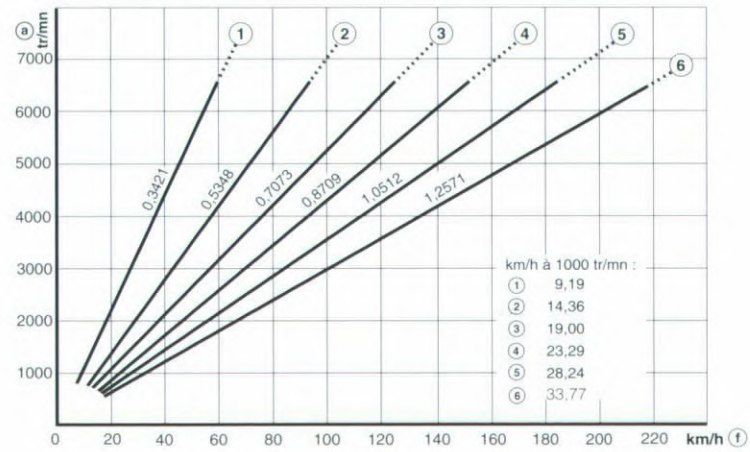

XUD9 A/L3

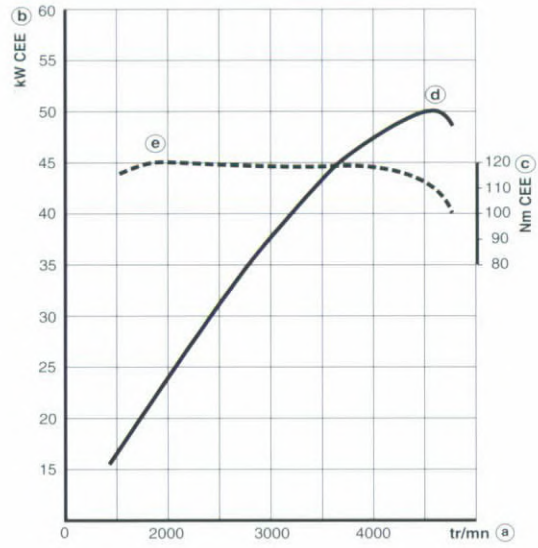

BE 3.5

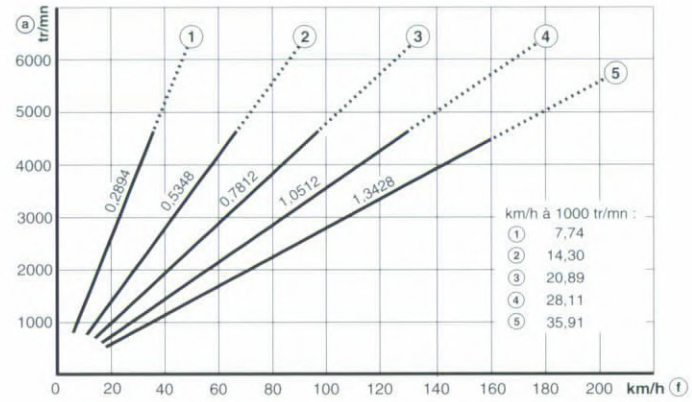

XUD9 TE/L3

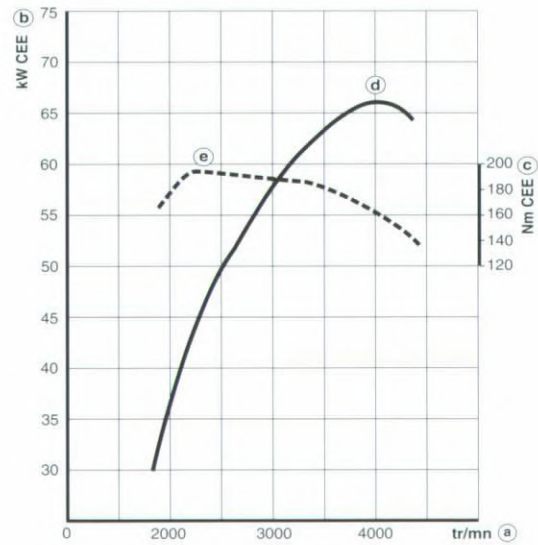

BE 3.5

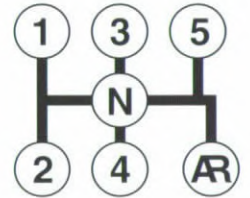
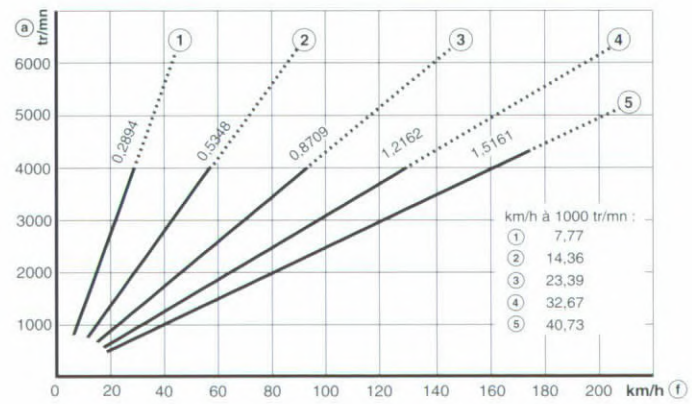



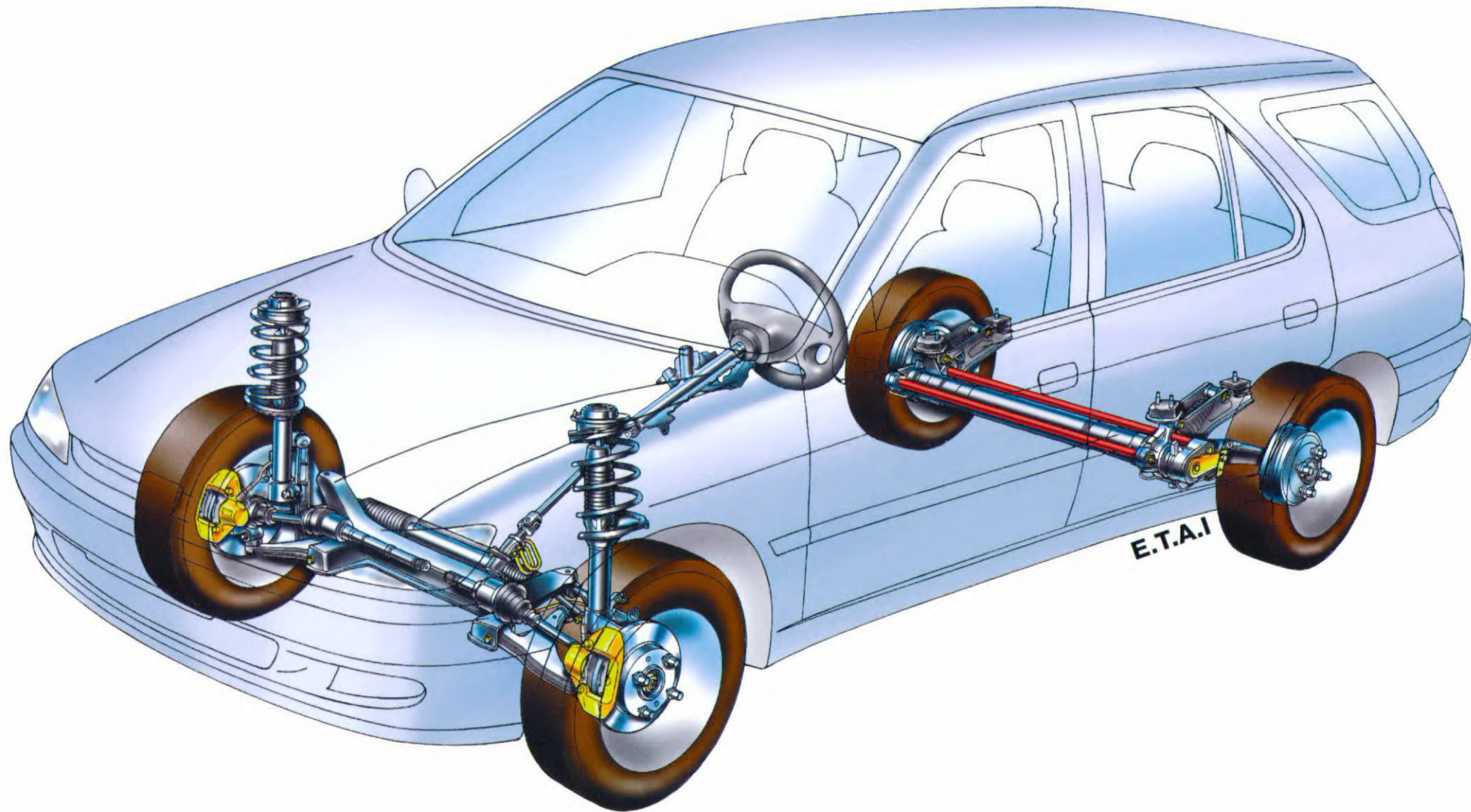



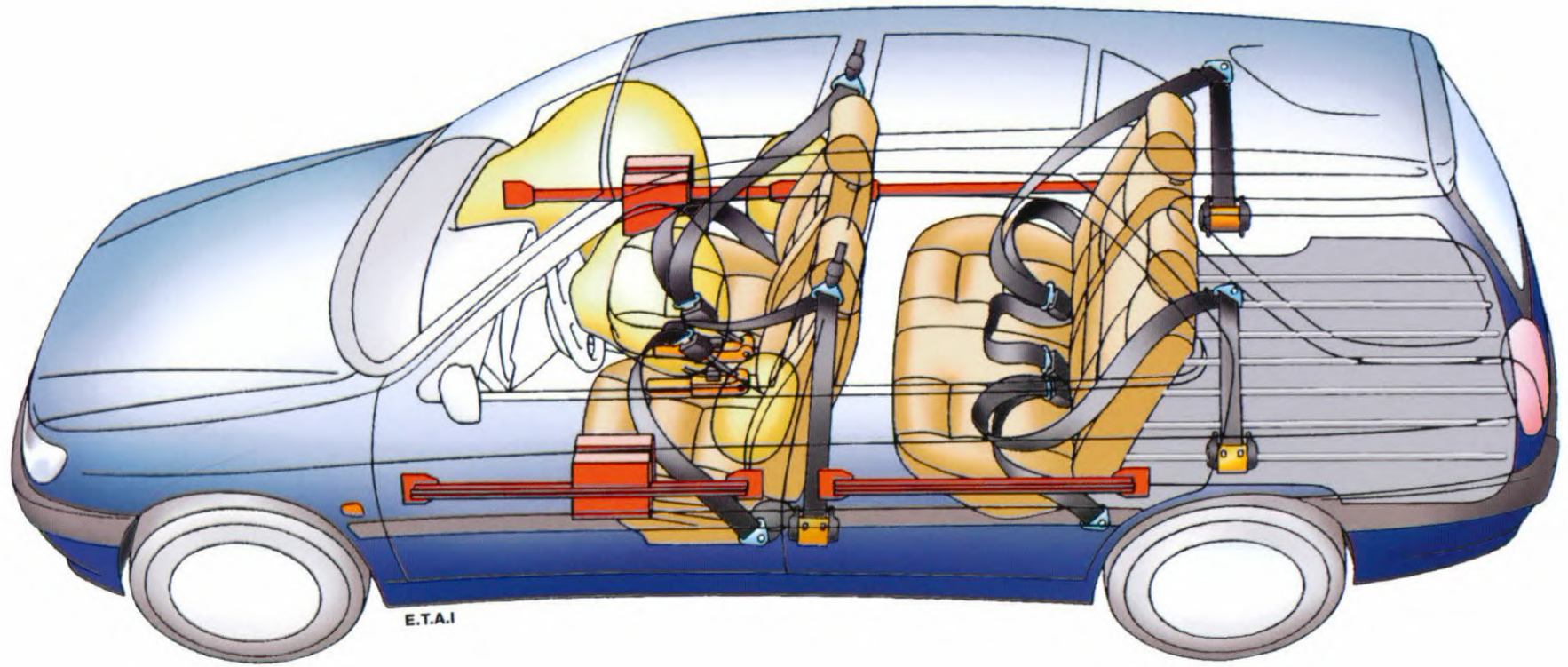



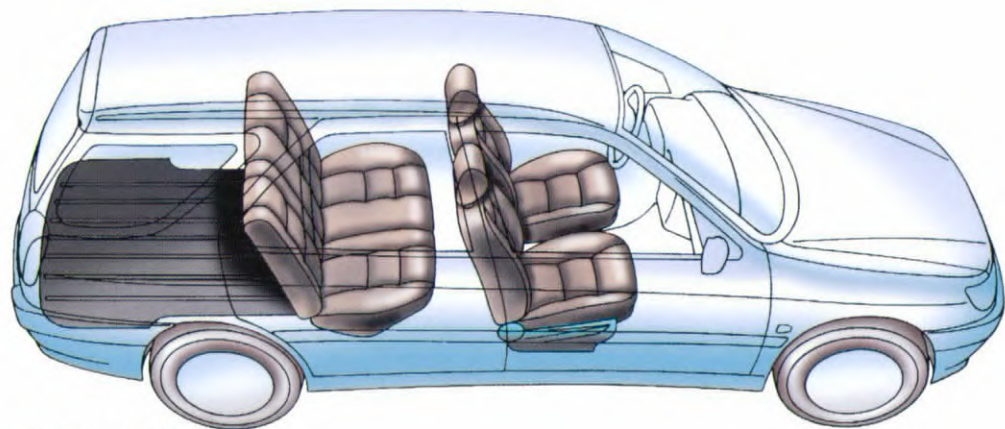

442 dm³

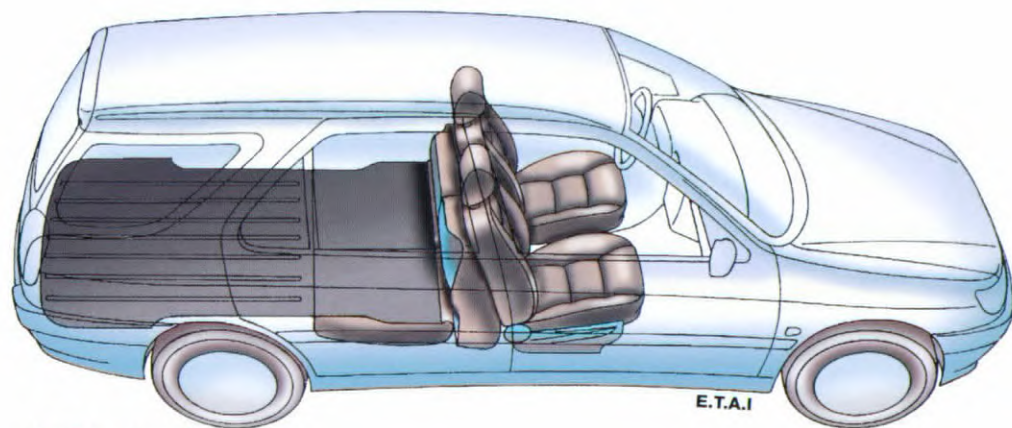
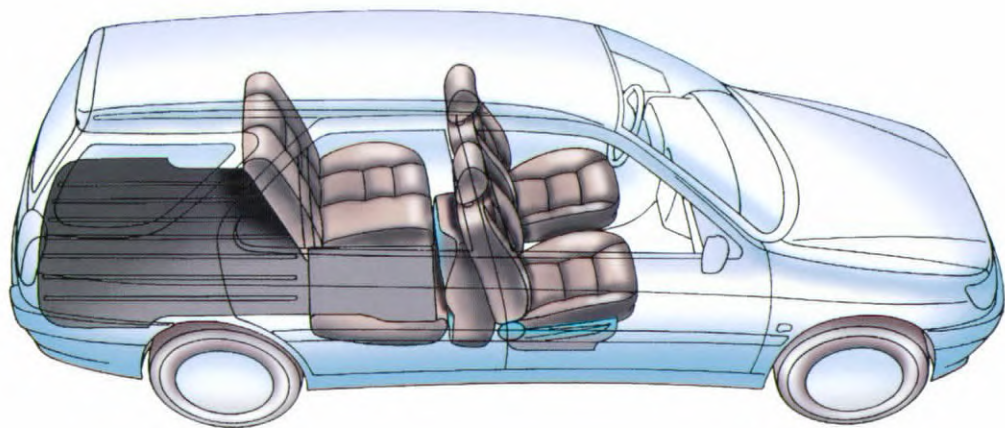
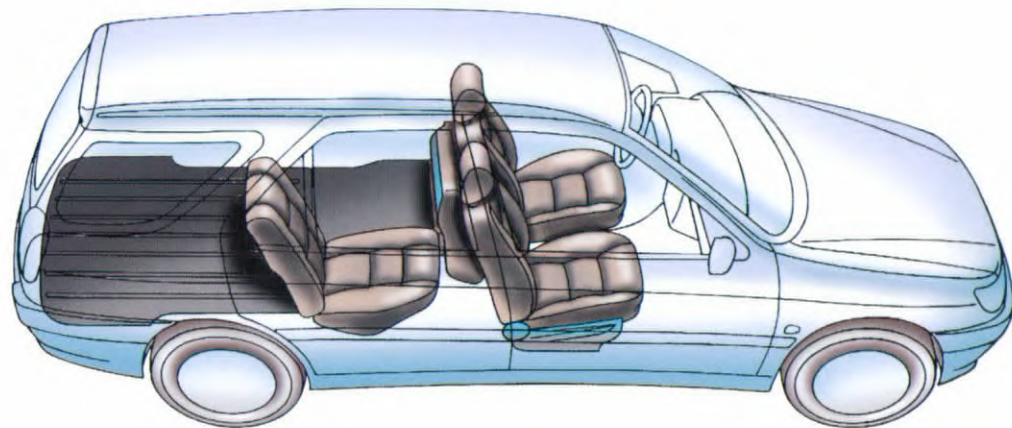

1512 dm³





